

SULLAIR

CENTRIFUGAL COMPRESSORS

T-SERIES & f-SERIES

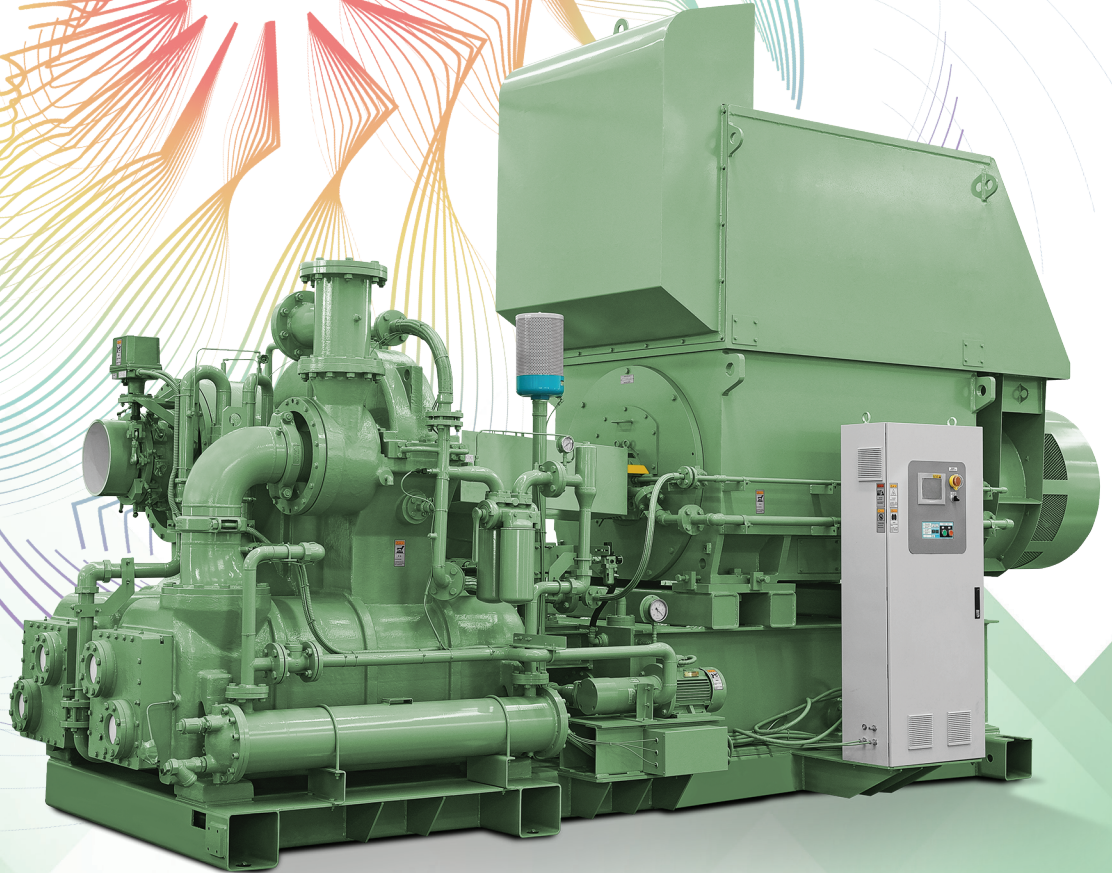

OIL FREE

SULLAIR®

WHY SULLAIR CENTRIFUGALS?

In 2004 IHI-Sullair, a joint venture focused on developing and producing high performance centrifugal compressors, was formed. Those compressor models, with more than a decade of quality performance, are now available through Sullair channels.

IHI-Sullair Compression Technology is a joint venture between Ishikawajima-Harima Heavy Industries Co., Ltd. (IHI) and Sullair combining two industry experts to design, produce and sell advanced centrifugal compressors.

For more information on the IHI-Sullair joint venture, please visit: www.ihisullair.cn/index.php/en/

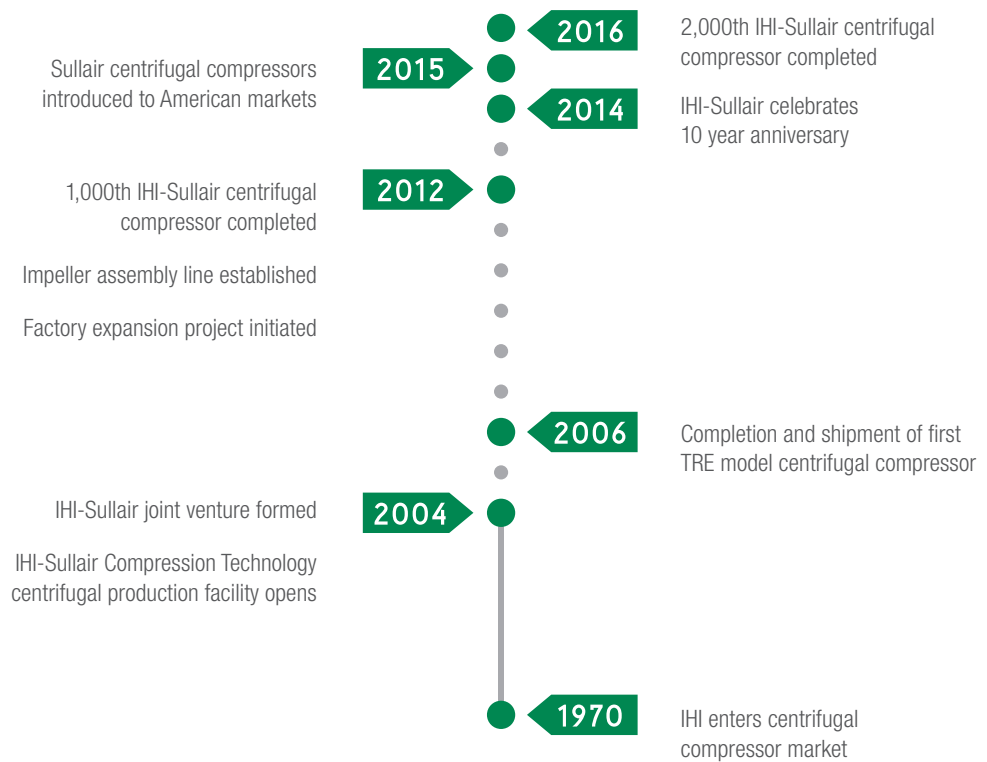

Efficient aerodynamics and low maintenance make centrifugal compressors ideal for a variety of industrial applications, including:

- Automotive
- Heavy-duty manufacturing
- Oil and gas
- Pharmaceuticals
- Chemical
- Electronics
- Aerospace and high-technology manufacturing
- Food and beverage production
- Utilities/power generation
- Transportation

Sullair centrifugal compressors are the ideal choice for those customers looking for:

Energy Efficiency — advanced technology impellers specifically designed to match the required airflow and pressure, contributing to energy savings.

Low Maintenance Costs — designed with many non-contacting internal components requiring minimal periodic maintenance, all moving parts are easily inspected by simply removing the horizontally-split gear cover.

Reliability and Durability — a robust, time-proven design helps Sullair Centrifugal compressors achieve unparalleled reliability and durability. Additionally, most models include Titanium impellers as standard providing additional strength while resisting corrosion and wear. (TRX model compressors feature stainless steel impellers.)

Class 0 Oil Free Air — for applications where air purity is essential, including pharmaceuticals, food and beverages, electronics, automotive painting and textiles.

Sullair centrifugal compressors are tested to meet oil free requirements under ISO-8573-1



Air Quality Standards ISO 8573.1 Classes

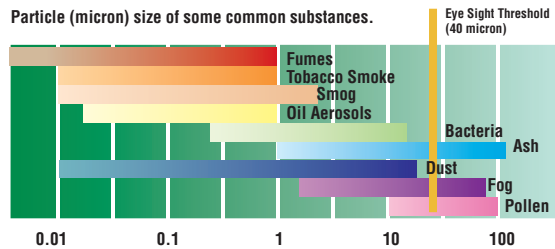

Class	Solid Particle Maximum number of particles per m ³			Pressure Dew Point °F (°C)	Oil (incl. vapor) mg/m ³
	0.1-0.5 micron	0.5-1.0 micron	1.0-5.0 micron		
0	As specified by the end-user or manufacturer, and more stringent than Class 1				
1	≤ 20,000	≤ 400	≤ 10	≤ -94° (-70°)	0.01
2	≤ 400,000	≤ 6000	≤ 100	≤ -40° (-40°)	0.10
3	-	≤ 90,000	≤ 1000	≤ -4° (-20°)	1.00
4	-	-	≤ 10,000	≤ 37.4° (3°)	5.00
5	-	-	≤ 100,000	≤ 44.6° (7°)	-
6	-	-	-	≤ 50° (10°)	-

Sullair Centrifugal Compressors: T-Series

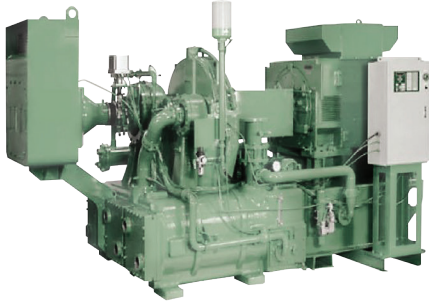

TRA CENTRIFUGAL COMPRESSOR

	Min	Max
hp	275	675
kW	210	500
cfm	1175	2900
psi	60	160
LxWxH in (mm)	146 x 79 x 79 (3700 x 2000 x 2000)	157 x 79 x 87 (4000 x 2000 x 2200)
Wt lbs (kg)	15,650 (7100)	18,740 (8500)

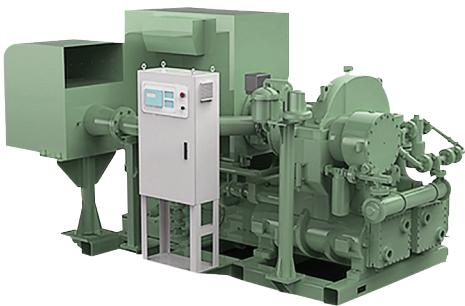

TX CENTRIFUGAL COMPRESSOR

	Min	Max
hp	325	535
kW	245	400
cfm	1050	2470
psi	60	145
LxWxH in (mm)	87 x 51 x 55 (2200 x 1300 x 1400)	130 x 91 x 83 (3300 x 2300 x 2100)
Wt lbs (kg)	12,125 (5500)	16,315 (7400)

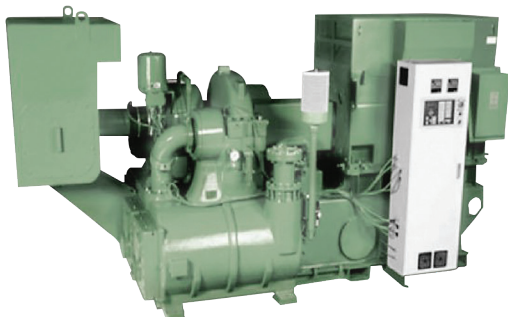

TRE CENTRIFUGAL COMPRESSOR

	Min	Max
hp	500	1250
kW	373	932
cfm	2000	6200
psi	30	230
LxWxH in (mm)	161 x 78 x 79 (4100 x 1950 x 2000)	205 x 91 x 110 (5200 x 2300 x 2800)
Wt lbs (kg)	18,300 (8300)	29,760 (13,500)

Up to 4-Stage available

TRX CENTRIFUGAL COMPRESSOR

	Min	Max
hp	900	2300
kW	670	1715
cfm	5300	11,750
psi	60	145
LxWxH in (mm)	161 x 78 x 79 (4100 x 1950 x 2000)	205 x 91 x 110 (5200 x 2300 x 2800)
Wt lbs (kg)	28,660 (13,000)	40,785 (18,500)

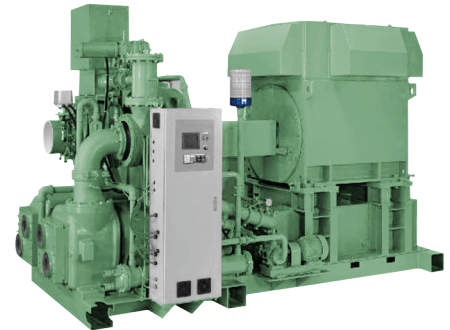

T3 CENTRIFUGAL COMPRESSOR

	Min	Max
hp	1000	1750
kW	746	1305
cfm	4800	8000
psi	30	215
LxWxH in (mm)	181 x 89 x 79 (4600 x 2250 x 2000)	224 x 98 x 118 (5700 x 2500 x 3000)
Wt lbs (kg)	22,045 (10,000)	35,275 (16,000)

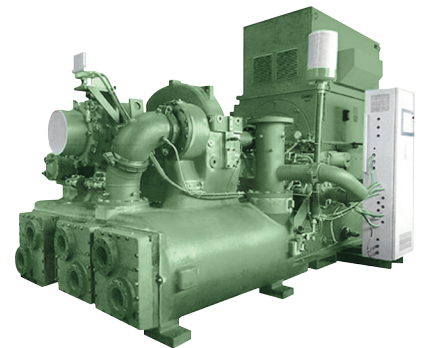

All T-Series Compressors come in complete packages.

Advanced Technology of Sullair Centrifugal Compressors

INLET GUIDE VANE/IGV

Inlet Guide Vanes impart a whirling motion to the inlet air flow in the same rotational direction as the first stage impeller. This reduces the work performed by the impeller, thus less power is required to deliver rated air flow and pressure. Compared with a butterfly valve, the IGV can guide gas flow direction, saving up to 10% power consumption when not in full load operation and provides a wider turndown range. IGV is standard on all Sullair models.

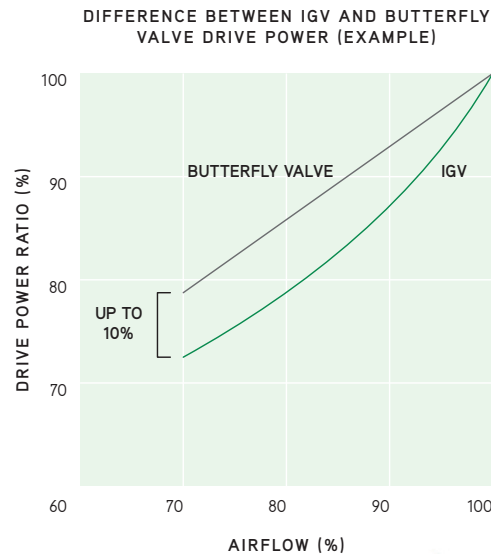

GEARBOX

The single piece gearbox has a robust design with integrated coolers which is more stable and reduces vibration when compared to a separated design.

- Accessible horizontally split gearbox for quick inspection
- Intercooler and aftercooler bundles are easily removable for cleaning
- The gearbox, cooler cavities, air passages and inlets are all treated with an epoxy coating to inhibit corrosion

HOW THE TECHNOLOGY WORKS

High-Powered Impellers

The three dimensional shape of the impellers utilizes the most modern aerodynamics for optimized energy efficiency. The TRX features stainless steel impellers; all other models provide additional strength with titanium impellers as standard.

Labyrinth Shaft Seals

Labyrinth type air and oil seals do not contact the pinion shaft — resulting in no operational wear on the seals. The gearbox is constantly maintained at slight negative pressure by an ejector fan — preventing oil leakage from the oil seal.

Diffusers

The energy imparted to air by the impeller rotation is efficiently converted into static pressure by the diffuser. The high-efficiency advanced-design diffuser inhibits turbulence and reduces noise.

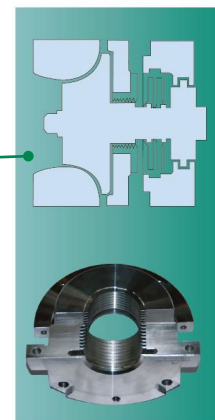

TRX CENTRIFUGAL COMPRESSOR

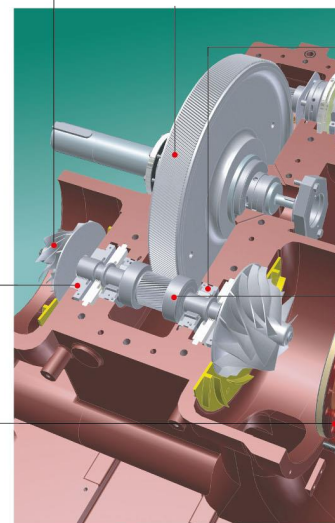

TRIFUGAL ESSOR

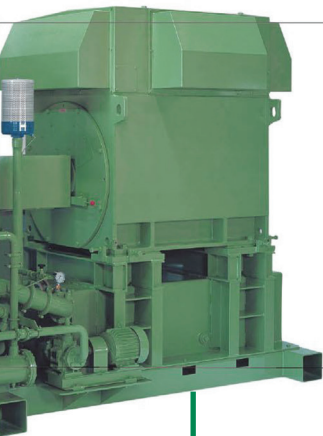

POWER COUPLING

Dry stainless steel disc coupling requires no lubrication, while the safety protection cover provides easy access for maintenance.

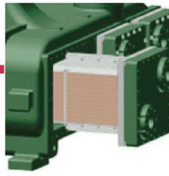

COOLERS

Cooler tube bundles are easily accessible without disturbing other components. Intercoolers and aftercoolers are water-in-tube design. Straight-through heat exchanger tubes with external fins allow easy maintenance to maintain high efficiency.

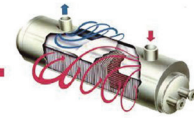

AERODYNAMIC INLETS

The inlets are specially treated with an epoxy coating to inhibit corrosion.



Bull Gear Bearings

A combination of journal and thrust bearings helps provide maximum reliability compared to roller bearings. T2, TX and TRA models also include ball bearings on the bull gear.

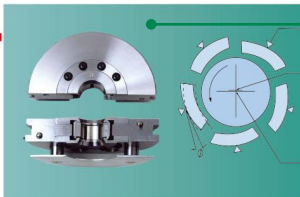

Tilting Pad Journal Bearings

Designed to ensure the shaft center is maintained at the center of the bearing, the Tilting Pad Journal Bearing eliminates shaft vibrations which helps ensure stable operation. Pad inclination is automatically adjusted according to bearing load changes from load or no-load conditions. The design allows for rapid and smooth responsiveness during a variety of load conditions.

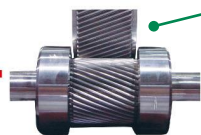

Thrust Collars

The axial thrust force generated by the impeller is transmitted through the thrust collars to the bull gear. This construction increases the stability of the impeller rotation, improving mechanical efficiency and reducing potential frictional losses.

Energy Efficiency; Low Maintenance; Ease of Operation



OUR FOCUS

All Sullair Centrifugal compressors rely on a simple design — which not only reduces the potential for mechanical loss, but also simplifies maintenance and operation.

ENERGY EFFICIENCY

The optimal combination of components — from specially designed impellers to tilting pad journal bearings — help Sullair centrifugal compressors operate with high efficiency which results in lower power consumption.

LOW MAINTENANCE

The simple design means fewer moving parts. Because many of the components have very low potential for wear, ongoing maintenance is significantly reduced. The horizontally split gearbox bearing, along with a split bearing and seal design, offers easy and convenient access to maintenance items: all moving parts can be checked by simply removing the gearbox cover.

EASE OF OPERATION

Sullair Centrifugal Compressors are designed to be installed — and provide ongoing reliable operation. The compressor is equipped with many features packaged as standard — minimizing installation time.

- Non-contacting internal components
 - Anti-reverse rotation main shaft oil pump
 - Carefully selected materials and components to withstand diverse and harsh operating conditions
-

Advanced PLC Control System Multiple Modes for Different Applications

Local Control Panel

- Allen-Bradley or Siemens controls are standard on all models
- The local control panel allows the operator to easily track and monitor system performance.
- Operating Conditions: key measurements, data and operating conditions
- Alerts - in the occurrence of a system event, indicator alerts provide both the cause of the incident as well as recommended corrections
- Recall Data - data can be recorded and kept for shutdown events, helping to investigate and diagnose the causes
- Diagnosis - monitors and provides recommendations for maintenance of suction and oil filters
- PLC Control System - monitors changes in air variables (suction air temperature; air demand) and adjusts compressor operation to ensure maximum efficiency

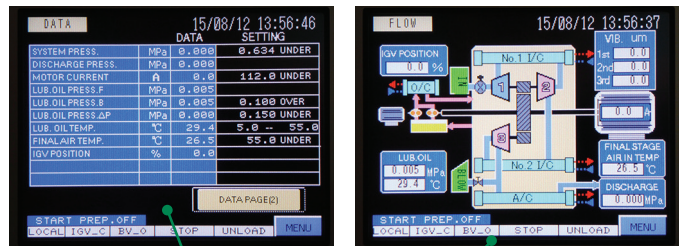

TRE 1,000 HP MODEL

Load/Unload Control

- The load/unload control mode provides an efficient compressor operating mode for some applications
- The load/unload control mode is similar to constant pressure until reaching the surge control point. At that point, the compressor will unload until the system pressure drops where the compressor will reload.
- Most energy efficient method of control with a turndown range of 20-50% without blowing off

Constant Pressure Control

- The constant pressure control method is used when air system pressure must be held steady at a specific value or in processes when large swings in air system pressure cannot be tolerated. With constant pressure control methods, the compressor never goes through the unloading cycle. The controller coordinates the adjustments of both the Inlet Guide Vane and modulating Blow Off Valve to the optimum operating point while minimizing energy usage and atmospheric blow off. The result is continuous air delivery at a constant discharge pressure and overall system flexibility.

Sullair f-series Centrifugal Compressors

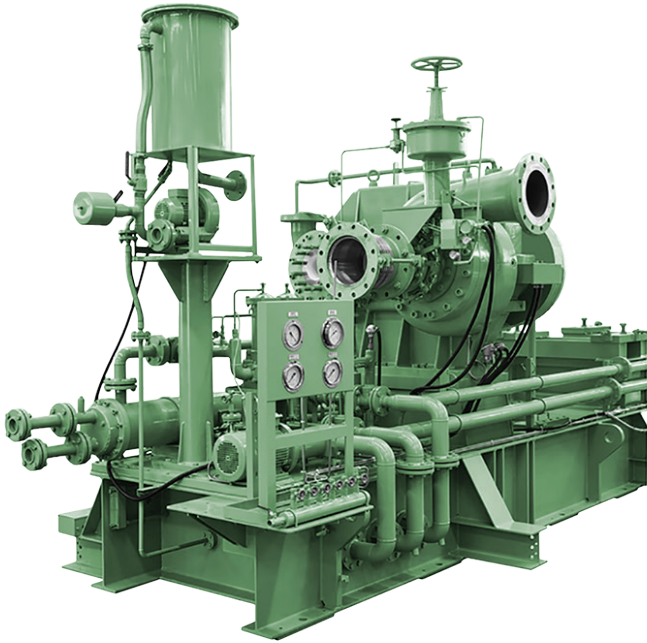

f-series compressors are high performance, custom designed compressors to meet your specific needs. Like the T-series, the f-series features the following characteristics:

- Class 0 oil free air
- Highly efficient design to reduce energy usage
- Horizontal split design gearbox allowing easy access to all moving parts simplifying maintenance

Then the f-series takes flexibility, power and pressure to a higher level.

f-series compressors are available in both packaged and non-packaged options, with compression available from single-stage up to four stages.



Sullair Centrifugal Compressors: f-series

Standard Configurations Shown

f25-44 Series

- **Model: f 25/30/36/44**
- **Packaged 1-4 stages**
- Flow Rate: 1200~30,000 cfm
- Discharge Pressure:
 - 15~230 psi (f 25/30)
 - 15~360 psi (f 36/44)

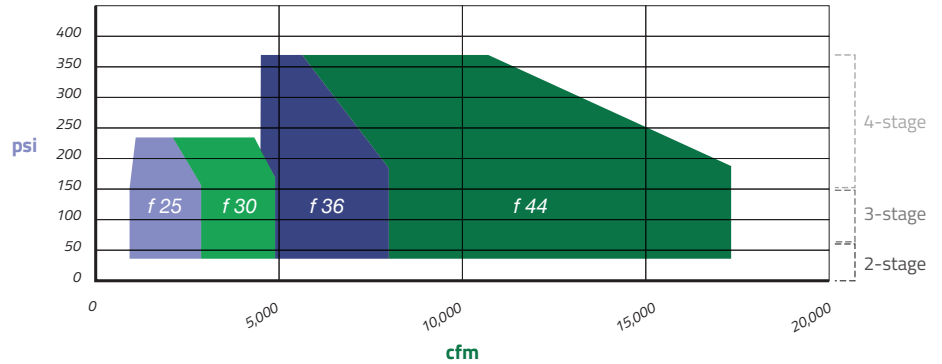

f53-115 Series

- **Model: f 53/64/78/95/115**
- **Non-Packaged 3-4 stages**
- Flow Rate: 20,000~118,000 cfm
- Discharge Pressure:
 - 15~360 psi (f 53/64)
 - 15~230 psi (f 78/95/115)

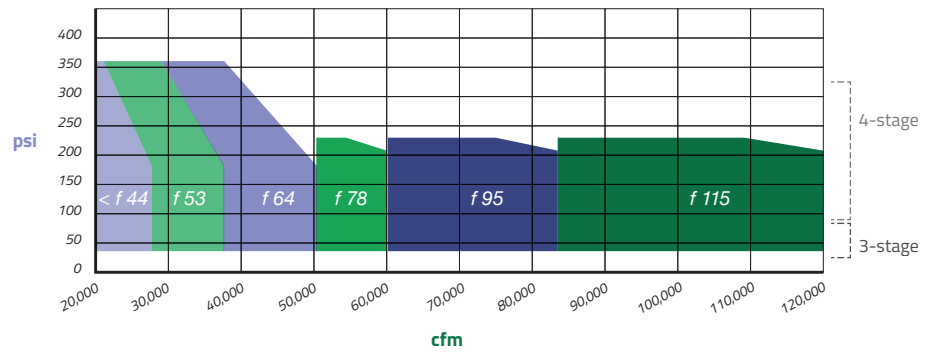

f25-f53 Series

- **Model: f 25H/30H/36H/44H/53H**
- **3-4 stages**
- Flow Rate: 1340~12,000 cfm
- Discharge Pressure: 230~725 psi
- Can be used for recycle and booster air compressor applications

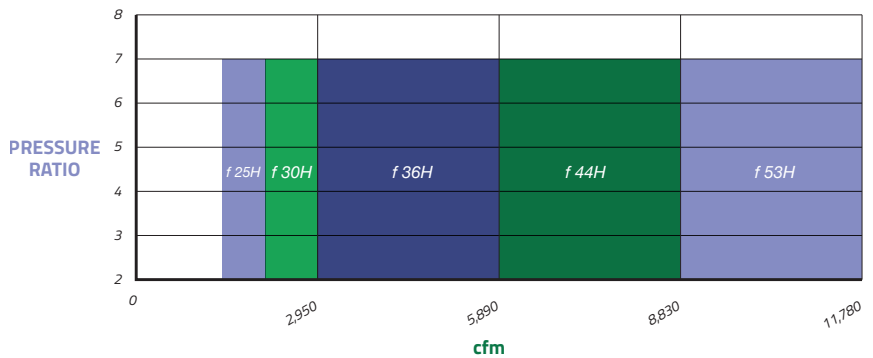

Sullair f-series compressors may be custom configured to meet your specific requirements, including a range of pressures and flows. For more information, contact OilFree@Sullair.com.

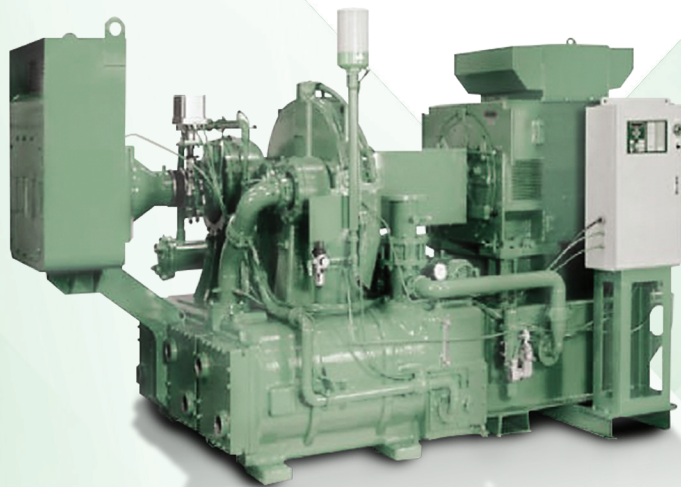

For more information, contact OilFree@Sullair.com